

### DESCRIPTION

The MP5087A is a load switch to provide 7A load protection covering 0.5V to 5.5V voltage range. With the small  $R_{DS(ON)}$  in tiny package, MP5087A provides very high efficient and space saving solution in notebook and tablet or other portable devices applications.

With the soft start function, the MP5087A can avoid inrush current during circuit start up. MP5087A also provides different functions, like programmable soft start time, output discharge function, OCP and thermal shutdown features.

The maximum load at the output (source) is current limited. This is accomplished by utilizing a sense FET topology. The magnitude of the current limit is controlled by an external resistor from ILIM pin to ground.

Tiny 12 pins QFN 2mmx2mm of MP5087A is available in space saving package.

### ELECTRICAL SPECIFICATION

Parameter	Symbol	Value	Units
Input Voltage	$V_{IN}$	0.5–5.5	V
Input $V_{CC}$ Voltage	$V_{CC}$	3–5.5	V
Output Voltage	$V_{OUT}$	0.5–5.5	V
Output Current	$I_{OUT}$	7	A

### FEATURES

- Integrated 10m $\Omega$  Low  $R_{DS(ON)}$  FETs
- Adjustable Start Up Slew Rate
- Wide  $V_{IN}$  Range from 0.5V to 5.5V
- <1 $\mu$ A Shutdown Current
- Programmable 7A Current Limit Range
- Output Discharge Function
- Enable Pin
- Push Pull PG Indicator for  $V_{IN}>3V$
- <200ns Short-Circuitry Response Protection
- Thermal Protection
- Small QFN 2mmx2mm Package for Space Saving

### APPLICATIONS

- Notebook and Tablet Computers
- Portable Devices
- Solid State Drivers
- Handheld Devices

All MPS parts are lead-free and adhere to the RoHS directive. For MPS green status, please visit MPS website under Quality Assurance. "MPS" and "The Future of Analog IC Technology", are Registered Trademarks of Monolithic Power Systems, Inc.

### EV5087A-G-00A EVALUATION BOARD



<b>Board Number</b>	<b>MPS IC Number</b>
EV5087A-G-00A	MP5087AGG

## EVALUATION BOARD SCHEMATIC

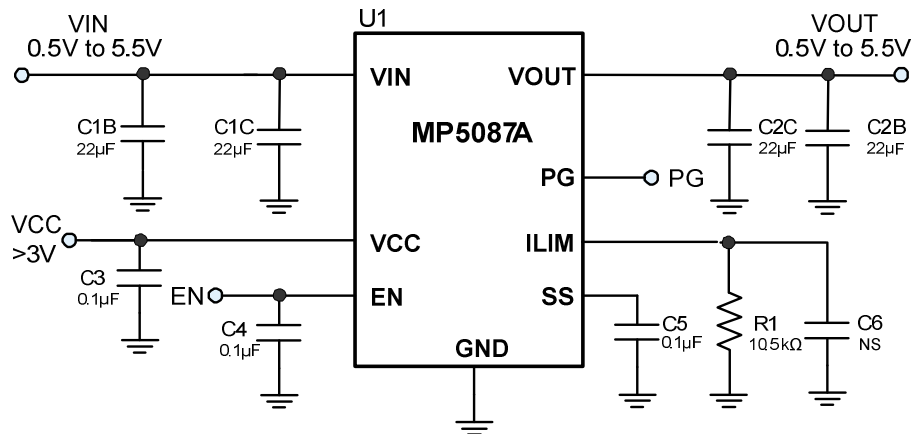

## EV5087A-G-00A BILL OF MATERIALS

Qty	RefDes	Value	Description	Package	Manufacturer	Manufacturer P/N
4	C1B, C1C C2B, C2C	22µF	Ceramic Cap, 10V, X5R	1206	muRata	GRM31CR61A226ME19L
3	C3, C4, C5	0.1µF	Ceramic Cap, 16V, X7R	0603	muRata	GRM188R71C104KA01D
0	C6	NS				
1	R1	10.5kΩ	Film Res,1%	0603	ROYAL	RL0603FR-0710K5L
1	U1		7A Load Switch	QFN12 2mmx2mm	MPS	MP5087AGG

## EVB TEST RESULTS

Performance waveforms are tested on the evaluation board.

$V_{IN} = 3.6V$ ,  $V_{CC} = 3.6V$ ,  $R_{LIM} = 10.5k\Omega$ ,  $T_A = 25^\circ C$ , unless otherwise noted.

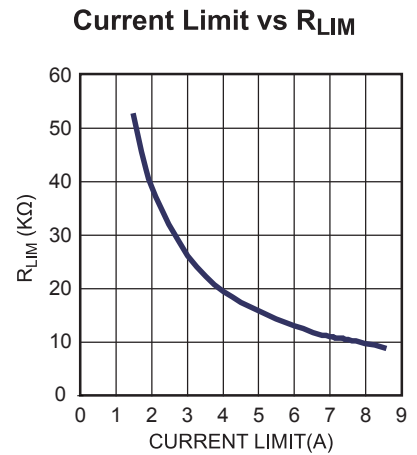
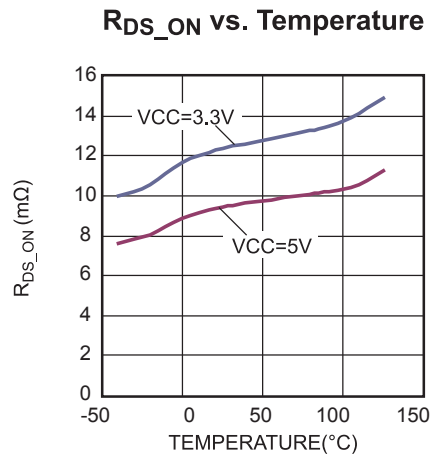
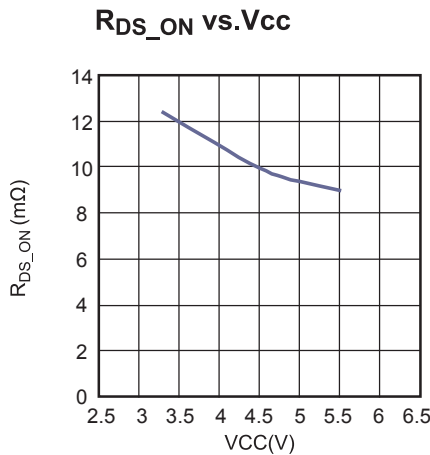
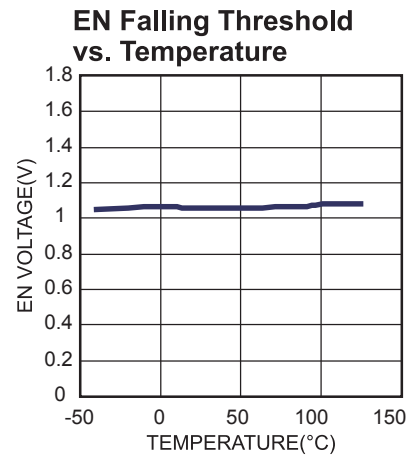
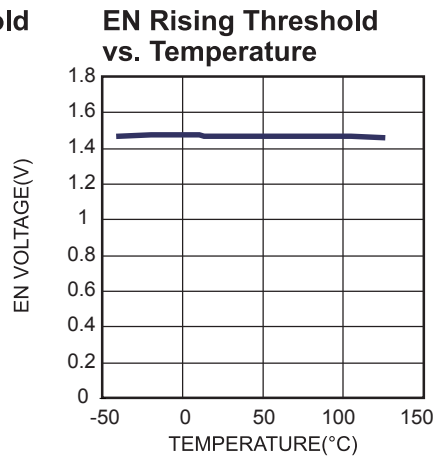
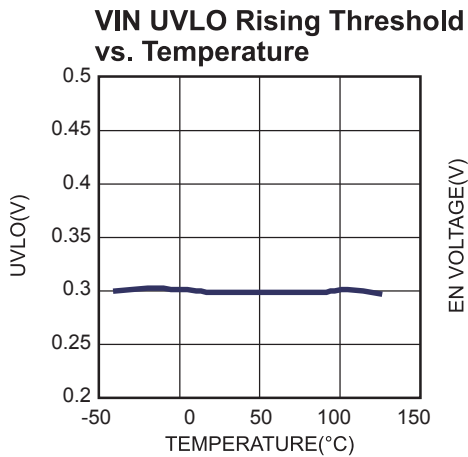
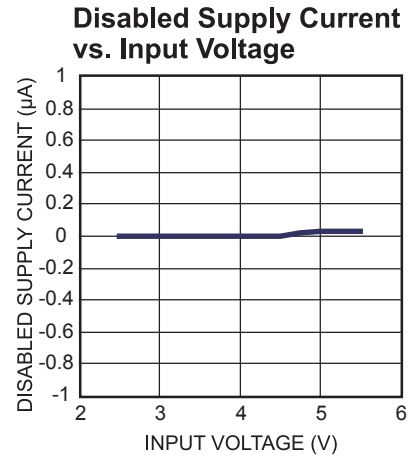
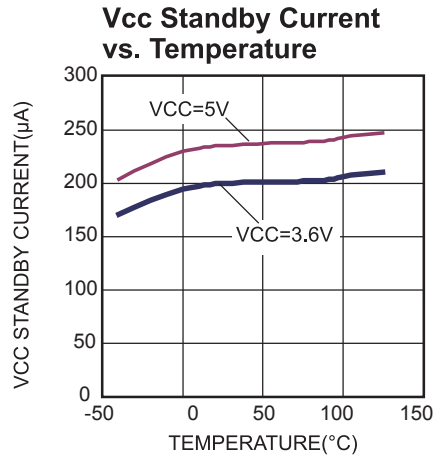
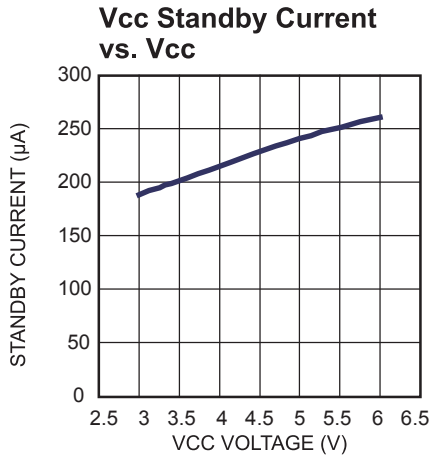

### EVB TEST RESULTS *(continued)*

Performance waveforms are tested on the evaluation board.

$V_{IN} = 3.6V$ ,  $V_{CC} = 3.6V$ ,  $R_{LIM} = 10.5k\Omega$ ,  $T_A = 25^\circ C$ , unless otherwise noted.

**$I_{LIM}$  vs. Temperature**

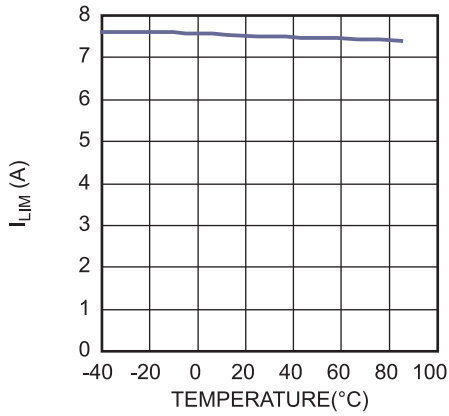

**Soft-Start vs. Cap**

$V_{IN} = 5V$ ,  $V_{CC} = 3.6V$

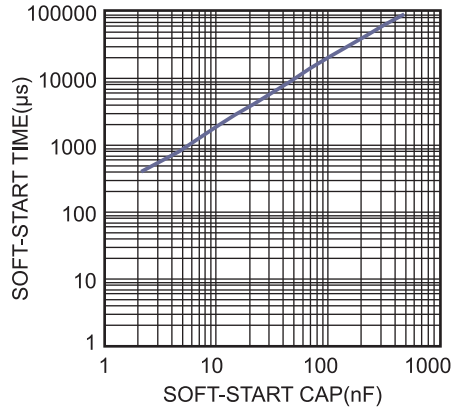

**Case Temperature Rise vs. Output Current**

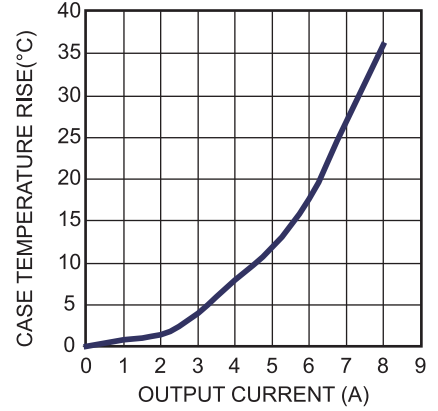

## EVB TEST RESULTS (continued)

Performance waveforms are tested on the evaluation board.

$V_{IN} = 3.6V$ ,  $V_{CC} = 3.6V$ ,  $R_{LIM} = 10.5k\Omega$ ,  $T_A = 25^\circ C$ , unless otherwise noted.

### Enable Startup

$V_{IN} = 3.6V$ ,  $V_{CC} = 3.6V$ , No Load

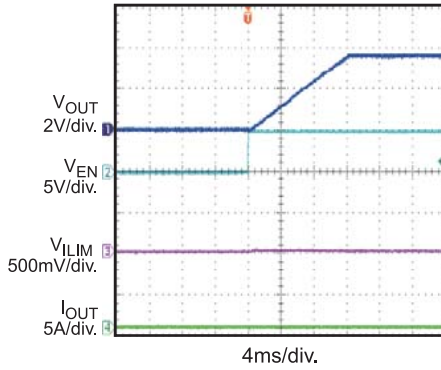

### Enable Startup

$V_{IN} = 3.6V$ ,  $V_{CC} = 3.6V$ , 7A Load

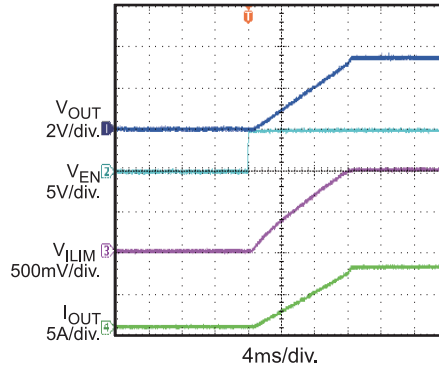

### Enable Shutdown

$V_{IN} = 3.6V$ ,  $V_{CC} = 3.6V$ , No Load

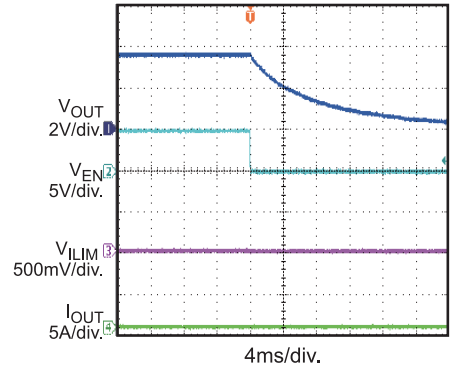

### Enable Shutdown

$V_{IN} = 3.6V$ ,  $V_{CC} = 3.6V$ , 7A Load

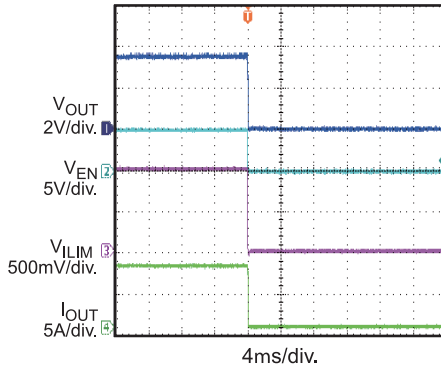

### Power Up

$V_{IN} = 3.6V$ ,  $V_{CC} = 3.6V$ , No Load

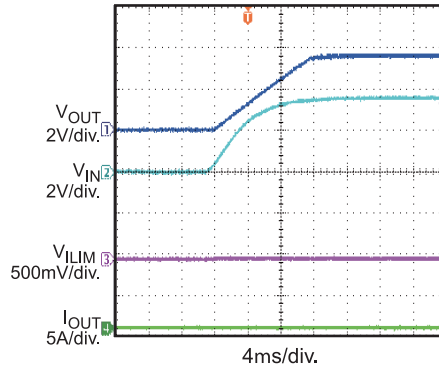

### Power Up

$V_{IN} = 3.6V$ ,  $V_{CC} = 3.6V$ , 7A Load

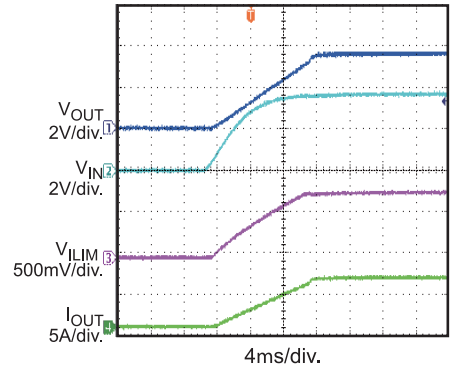

### Power Down

$V_{IN} = 3.6V$ ,  $V_{CC} = 3.6V$ , No Load

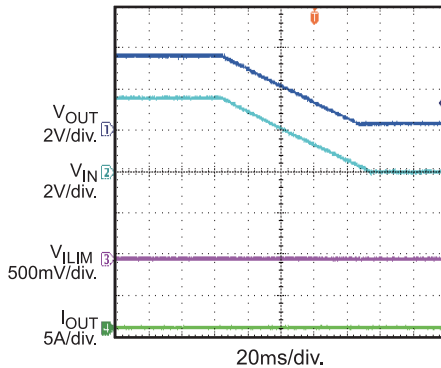

### Power Good

$V_{IN} = 3.6V$ ,  $V_{CC} = 3.6V$ , No Load

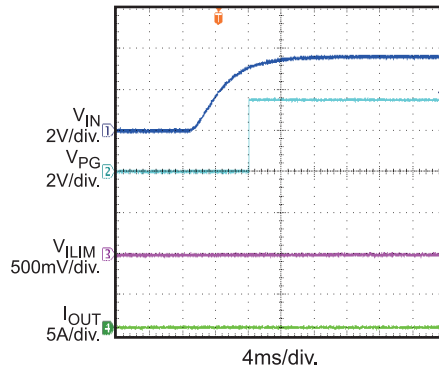

### Power Good

$V_{IN} = 3.6V$ ,  $V_{CC} = 3.6V$ , 7A Load

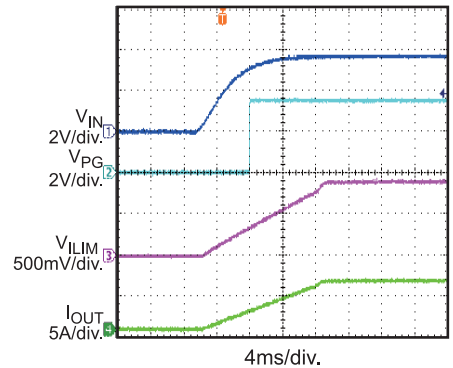

## EVB TEST RESULTS *(continued)*

Performance waveforms are tested on the evaluation board.

$V_{IN} = 3.6V$ ,  $V_{CC} = 3.6V$ ,  $R_{LIM} = 10.5k\Omega$ ,  $T_A = 25^\circ C$ , unless otherwise noted.

### Power Good

$V_{IN} = 3.6V$ ,  $V_{CC} = 3.6V$ , No Load

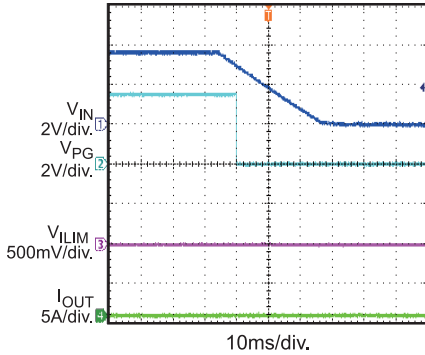

### Power Good

$V_{IN} = 3.6V$ ,  $V_{CC} = 3.6V$ , 7A Load

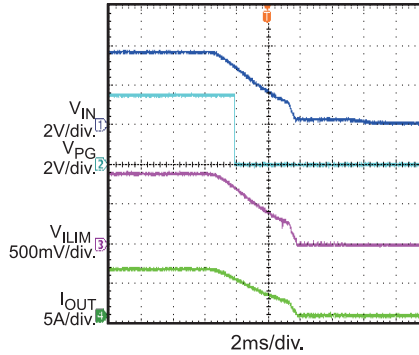

### Steady State

$V_{IN} = 3.6V$ ,  $V_{CC} = 3.6V$ , 7A Load

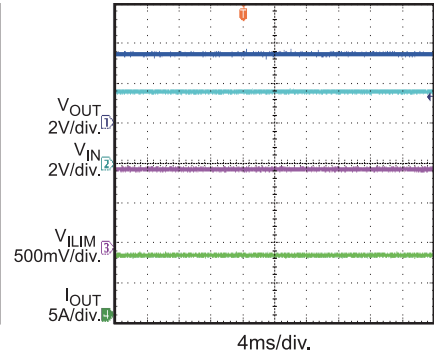

### Load Transient Response

$V_{IN} = 5V$ ,  $V_{CC} = 3.3V$ ,  $I_{OUT} = 0A-7A$

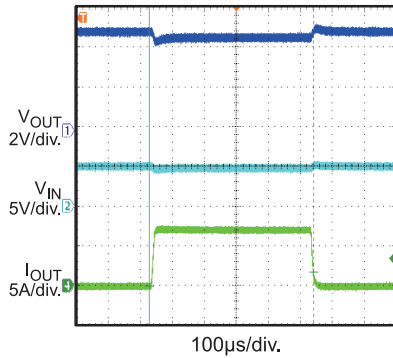

### SCP Enter

$V_{IN} = 5V$ ,  $V_{CC} = 3.3V$ ,  $R_{LIMIT} = 10.5k\Omega$

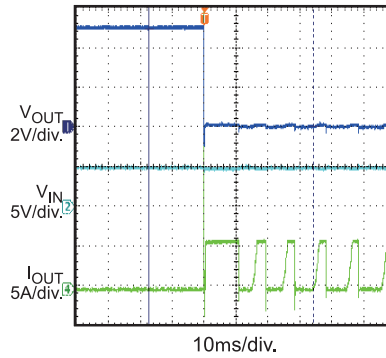

### SCP Steady State

$V_{IN} = 5V$ ,  $V_{CC} = 3.3V$ ,  $R_{LIMIT} = 10.5k\Omega$

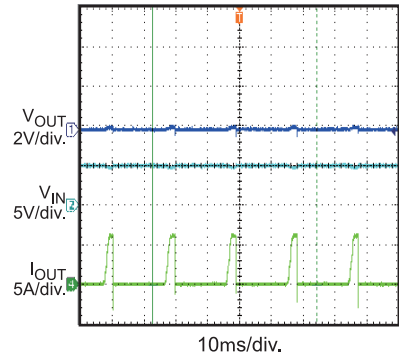

### SCP Recover

$V_{IN} = 5V$ ,  $V_{CC} = 3.3V$ ,  $R_{LIMIT} = 10.5k\Omega$

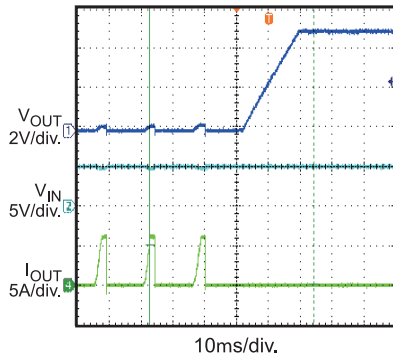

## PRINTED CIRCUIT BOARD LAYOUT

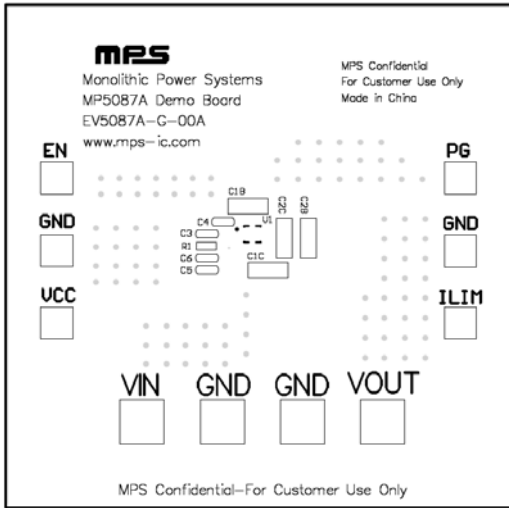

Figure 1—Top Silk Layer

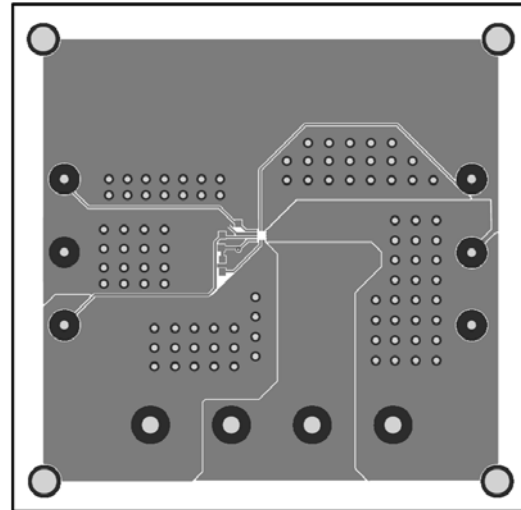

Figure 2—Top Layer

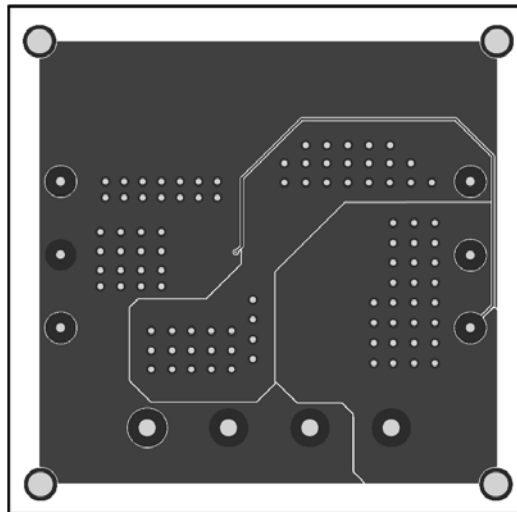

Figure 3—Bottom Layer

## QUICK START GUIDE

1. Connect the positive and negative terminals of the load to the VOUT and GND pins respectively.
2. Preset the power supply output between 0.5V and 5.5V, and then turn off the power supply.
3. Connect the positive and negative terminals of the power supply output to the VIN and GND pins respectively.
4. Follow the step 1-3 to set the VCC voltage between 3V and 5.5V.
5. Turn the power supply on.
6. To use the Enable function, apply a digital input to the EN pin. Drive EN higher than 1.5V to turn on the switch or less than 1.1V to turn it off.
7. Use R1 to set the output current limit, C5 to set the SS time. Follow the Application Information section in the device datasheet to select appropriate R1, C5.

**NOTICE:** The information in this document is subject to change without notice. Please contact MPS for current specifications. Users should warrant and guarantee that third party Intellectual Property rights are not infringed upon when integrating MPS products into any application. MPS will not assume any legal responsibility for any said applications.



# Mouser Electronics

Authorized Distributor

Click to View Pricing, Inventory, Delivery & Lifecycle Information:

[Monolithic Power Systems \(MPS\):](#)

[EV5087A-G-00A](#)